

IP 66 15-48V DC

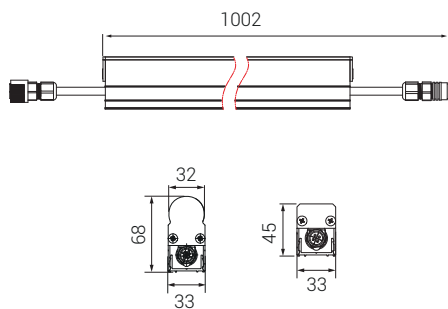

RDMX



- Min. 20 micron anodized aluminum extruded profile
- Stainless connectors
- PVC side cover with UV protection
- UV protective, diffused front cover
- Cooling capacity up to 36W/m
- Suitable for surface mounting
- Each piece can be produced at a max. length of 4 m
- RDMX configuration
- IP67 socket for DATA-SIGNALS

P W Product & Power Options

Model	Light Color	Input Voltage (V)	Power (W)	Dimension (mm)	LED Quantity (pcs)	Pixel Pitch (cm)
LL-RDMX-10-4X2,5	RGB	15-48V DC	2	102	4	4x2,5
LL-RDMX-50-4X2,5	RGB	15-48V DC	6	502	20	4x2,5
LL-RDMX-100-4X2,5	RGB	15-48V DC	11	1002	40	4x2,5
LL-RDMX-150-4X2,5	RGB	15-48V DC	16	1502	60	4x2,5

U Upper Piece Options



01: Diffuse cover

02: Flat Diffuse cover

03: Flat Polymer cover

M Mounting Options

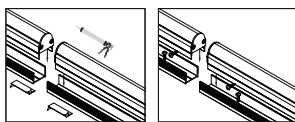

02: Silicone Double sided tape

14: Screw mounting



Order Code

P . W . U . M



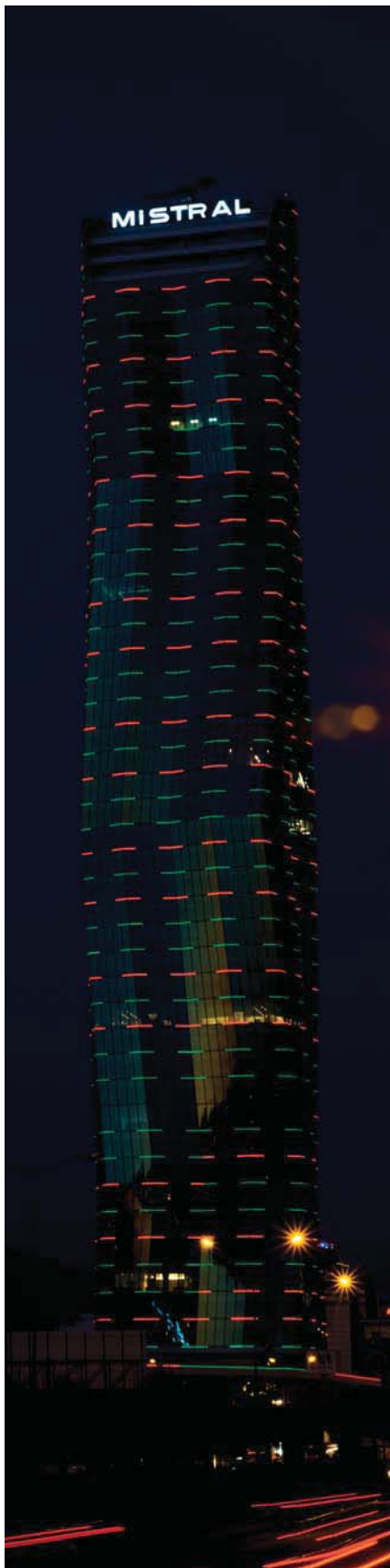

Mistral Tower, İzmir

Standard Connection Scheme

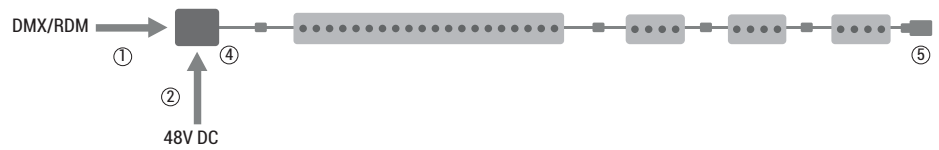

Connection Scheme with Extension Socket

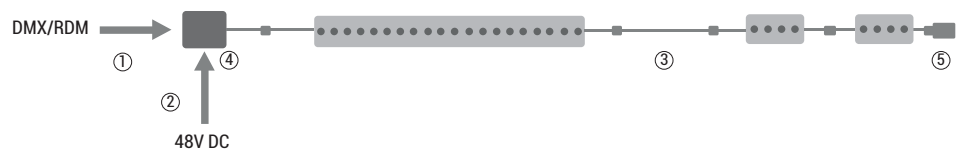

Combined Model Connection Scheme

DOT-RDMX-xx and LL-RDMX-xxx can be grouped together by DOT/LL combined chain model

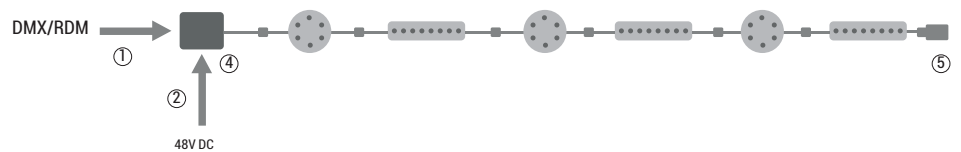

(1) DMX DATA CABLE, 33400474 : CABLE 2X0,22 KR-SY LI2Y(ST)CH TP GREY

(2) AC SUPPLY CABLE, 3x1mm TTR

(3) 26000xxx : SOCKET RDMX L:100/200/400/600/800/1000cm 4 PIN MALE-FEMALE DOUBLE SIDED EXTENSION IP67 (YM)



(4) 33600695 :RDMX INPUT JUNCTION BOX



(5) 33600696 : RDMX TERMINATOR

Accessories

33400474 : CABLE 2X0,22 KR-SY LI2Y(ST)CH TP GREY

26000122 : SOCKET RDMX L:100cm 4 PIN MALE-FEMALE DOUBLE SIDED EXTENSION IP67 (YM)

26000150 : SOCKET RDMX L:200cm 4 PIN MALE-FEMALE DOUBLE SIDED EXTENSION IP67 (YM)

26000151 : SOCKET RDMX L:400cm 4 PIN MALE-FEMALE DOUBLE SIDED EXTENSION IP67 (YM)

26000152 : SOCKET RDMX L:600cm 4 PIN MALE-FEMALE DOUBLE SIDED EXTENSION IP67 (YM)

26000153 : SOCKET RDMX L:800cm 4 PIN MALE-FEMALE DOUBLE SIDED EXTENSION IP67 (YM)

26000154 : SOCKET RDMX L:1000cm 4 PIN MALE-FEMALE DOUBLE SIDED EXTENSION



RDMX

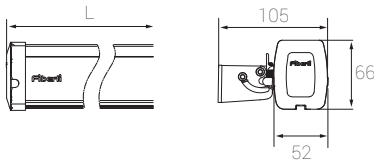

- Anodized aluminum extruded profile
- Polycarbonate luminaire glass
- PVC side covers with invisible gland outlet and UV protection
- Stainless steel fixture stand
- High efficiency group lens
- IP68 air vent
- RDMX configuration
- IP67 socket for DATA-SIGNALS

P W Product & Power Options

Product Name	Light Color	Input Voltage (V)	Power (W)	Length (L) (mm)	Weight (kg)
WL109-RDMX	RGB	220-240V AC	12	380	1,0
WL218-RDMX	RGB	220-240V AC	23	619	1,5
WL327-RDMX	RGB	220-240V AC	34	909	2,4
WL436-RDMX	RGB	220-240V AC	45	1199	2,9
WL112-RDMX	RGBW/A	220-240V AC	16	380	1,0
WL224-RDMX	RGBW/A	220-240V AC	31	619	1,5
WL336-RDMX	RGBW/A	220-240V AC	45	909	2,4
WL448-RDMX	RGBW/A	220-240V AC	60	1199	2,9

O Lens Options



XN: Extra Narrow Angle
N: Narrow Angle
M: Medium Angle
W: Wide Angle
E: Elliptical Angle

J Junction Options



01: Cable **02:** IP67 Socket

Only 220V

K Cable Direction Options

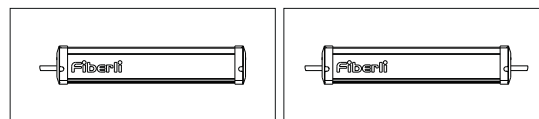

01: Single entry **03:** Dual entry and exit *

*Only for energy cable

M Mounting Options

Stand connector

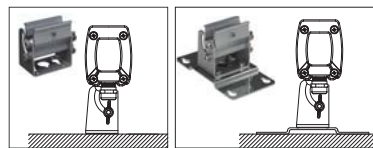

20: Standard Stand **21:** Standard stand/
Mounting kit

Optional Accessories

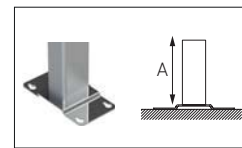

34: Extension piece A=5cm
35: Extension piece A=10cm
36: Extension piece A=20cm

Extension pieces at any desired length are optional



Order Code

P . W . O . J . K . M



Product Diagrams

Polar Diagram

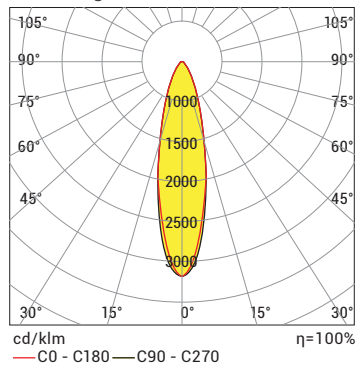

Polar Diyagramı

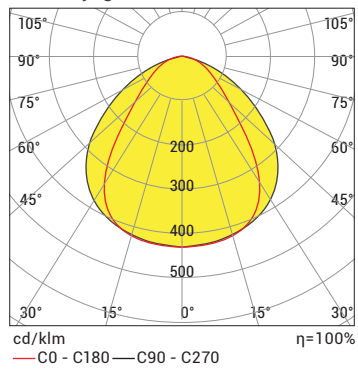

Connecting fittings



Additional Pieces Options



Dual assembly



Ternary assembly



Quaternary assembly



Standard Connection Scheme

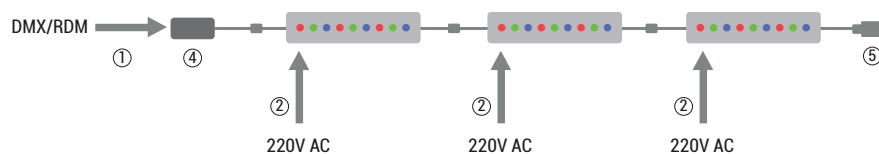

Connection Scheme with Extension Socket

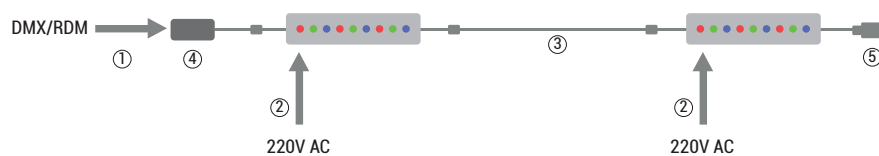

(1) DMX DATA CABLE, 33400474 : CABLE 2X0,22 KR-SY LI2Y(ST)CH TP GREY

(2) AC SUPPLY CABLE, 3x1mm TTR

(3) 26000xxx : SOCKET RDMX L:100/200/400/600/800/1000cm 4 PIN MALE-FEMALE DOUBLE SIDED EXTENSION IP67 (YM)



(4) 33600755 : RDMX INPUT JOINT



(5) 33600696 : RDMX TERMINATOR

Accessories

33400474 : CABLE 2X0,22 KR-SY LI2Y(ST)CH TP GREY

26000122 : SOCKET RDMX L:100cm 4 PIN MALE-FEMALE DOUBLE SIDED EXTENSION IP67 (YM)

26000150 : SOCKET RDMX L:200cm 4 PIN MALE-FEMALE DOUBLE SIDED EXTENSION IP67 (YM)

26000151 : SOCKET RDMX L:400cm 4 PIN MALE-FEMALE DOUBLE SIDED EXTENSION IP67 (YM)

26000152 : SOCKET RDMX L:600cm 4 PIN MALE-FEMALE DOUBLE SIDED EXTENSION IP67 (YM)

26000153 : SOCKET RDMX L:800cm 4 PIN MALE-FEMALE DOUBLE SIDED EXTENSION IP67 (YM)

26000154 : SOCKET RDMX L:1000cm 4 PIN MALE-FEMALE DOUBLE SIDED EXTENSION





RDMX

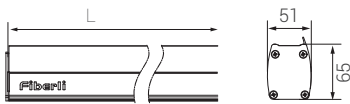
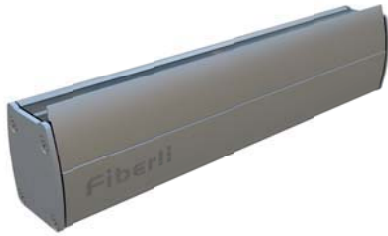

- Anodized aluminum extruded profile
- Polycarbonate luminaire glass
- PVC side covers with invisible gland outlet and UV protection
- Stainless steel fixture stand
- High efficiency group lens
- IP68 air vent
- RDMX configuration
- IP67 socket for DATA-SIGNALS

P W Product & Power Options

Product Name	Light Color	Input Voltage (V)	Power (W)	Length (L) (mm)	Weight (kg)
WLT109-RDMX	RGB	220-240V AC	12	360	1,0
WLT218-RDMX	RGB	220-240V AC	23	600	1,5
WLT327-RDMX	RGB	220-240V AC	34	900	2,4
WLT436-RDMX	RGB	220-240V AC	45	1190	2,9
WLT112-RDMX	RGBW/A	220-240V AC	16	360	1,0
WLT224-RDMX	RGBW/A	220-240V AC	31	600	1,5
WLT336-RDMX	RGBW/A	220-240V AC	45	900	2,4
WLT448-RDMX	RGBW/A	220-240V AC	60	1190	2,9

O Lens Options



XN: Extra Narrow Angle
N: Narrow Angle
M: Medium Angle
W: Wide Angle
E: Elliptical Angle

J Junction Options



01: Cable **02:** IP67 Socket

Only 220V

U Upper Cover Options

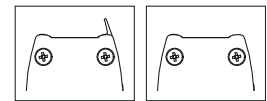

With Glare Shield **Without Glare Shield**

K Cable Direction Options



01: Single entry **03:** Dual entry and exit

*Only for energy cable

M Mounting Options

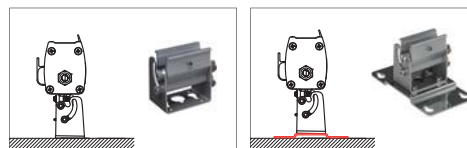

20: Standard Stand **21:** Standard stand/Mounting kit

Optional Accessories

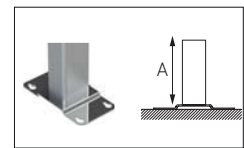

34: Extension piece A=5cm
35: Extension piece A=10cm
36: Extension piece A=20cm
 Extension pieces at any desired length are optional



Order Code

P . W . O . J . U . K . M



Product Diagrams

Polar Diagram

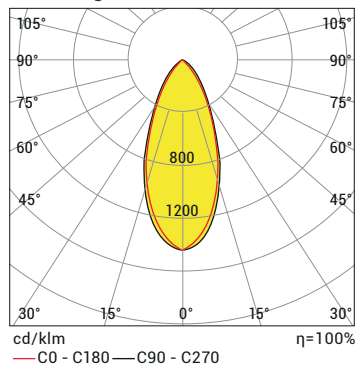

Standard Connection Scheme

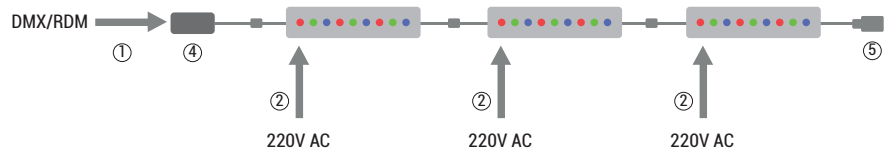

Connection Scheme with Extension Socket

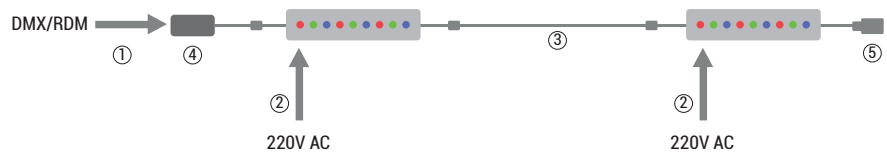

(1) DMX DATA CABLE, 33400474 : CABLE 2X0,22 KR-SY LI2Y(ST)CH TP GREY

(2) AC SUPPLY CABLE, 3x1mm TTR

(3) 26000xxx : SOCKET RDMX L:100/200/400/600/800/1000cm 4 PIN MALE-FEMALE DOUBLE SIDED EXTENSION IP67 (YM)



(4) 33600755: RDMX INPUT JOINT



(5) 33600696 : RDMX TERMINATOR

Accessories

33400474 : CABLE 2X0,22 KR-SY LI2Y(ST)CH TP GREY

26000122 : SOCKET RDMX L:100cm 4 PIN MALE-FEMALE DOUBLE SIDED EXTENSION IP67 (YM)

26000150 : SOCKET RDMX L:200cm 4 PIN MALE-FEMALE DOUBLE SIDED EXTENSION IP67 (YM)

26000151 : SOCKET RDMX L:400cm 4 PIN MALE-FEMALE DOUBLE SIDED EXTENSION IP67 (YM)

26000152 : SOCKET RDMX L:600cm 4 PIN MALE-FEMALE DOUBLE SIDED EXTENSION IP67 (YM)

26000153 : SOCKET RDMX L:800cm 4 PIN MALE-FEMALE DOUBLE SIDED EXTENSION IP67 (YM)

26000154 : SOCKET RDMX L:1000cm 4 PIN MALE-FEMALE DOUBLE SIDED EXTENSION



RDMX

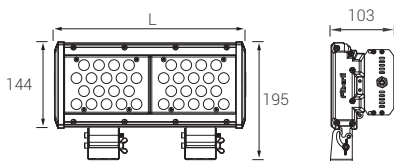

- Anodized aluminum extruded profile
- Electrostatic powder coated, aluminum injection end cap
- Stainless steel fixture stand
- Polycarbonate luminaire glass
- High efficiency group lens
- IP68 air vent
- RDM configuration
- IP67 socket for DATA-SIGNALS

P W Product & Power Options

Product Name	Light Color	Input Voltage (V)	Power (W)	Length (L) (mm)	Weight (kg)
WS236-RDMX	RGB	220-240V AC	45	320	2,9
WS354-RDMX	RGB	220-240V AC	67	477	4,3
WS472-RDMX	RGB	220-240V AC	89	609	5,3
WS232-RDMX	RGBW/A	220-240V AC	59	320	2,9
WS348-RDMX	RGBW/A	220-240V AC	88	477	4,3
WS464-RDMX	RGBW/A	220-240V AC	117	609	5,3

*Power and Lumen values provided are based off of a "cold white (CW) LED".

O Lens Options

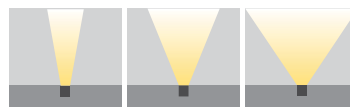

N: Narrow Angle M: Medium Angle W: Wide Angle

J Junction Options



01: Cable 02: IP67 Socket

M Mounting Options



20: Standard Stand 21: Standard stand/ Mounting kit

Optional Accessories

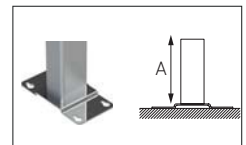

34: Extension piece A=5cm
35: Extension piece A=10cm
36: Extension piece A=20cm

Extension pieces at any desired length are optional

Additional Pieces Options

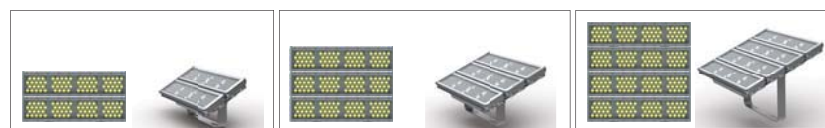

Dual Assembly

Triple Assembly

Quarted Assembly



Order Code

P . W . O . J . M



Product Diagrams

Polar Diagram

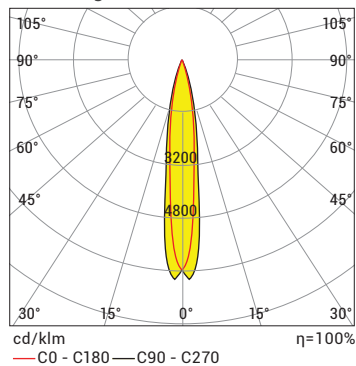

Polar Diagram

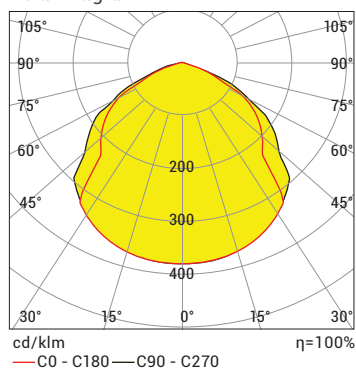

Standard Connection Scheme

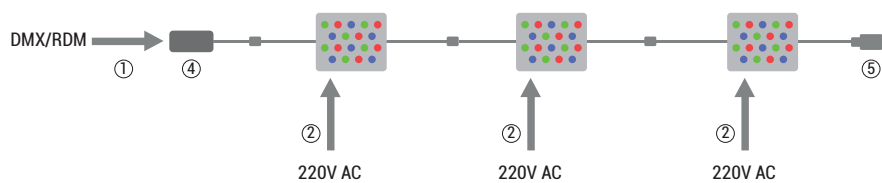

Connection Scheme with Extension Socket

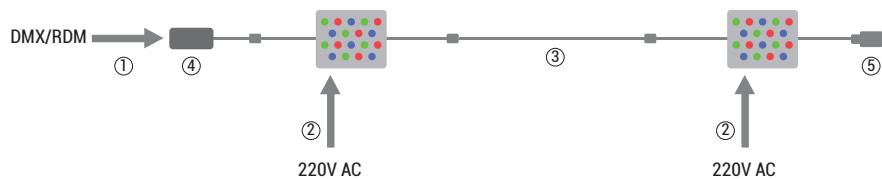

(1) DMX DATA CABLE, 33400474 : CABLE 2X0,22 KR-SY LI2Y(ST)CH TP GREY

(2) AC SUPPLY CABLE, 3x1mm TTR

(3) 26000xxx : SOCKET RDMX L:100/200/400/600/800/1000cm 4 PIN MALE-FEMALE DOUBLE SIDED EXTENSION IP67 (YM)



(4) 33600755: RDMX INPUT JOINT



(5) 33600696 : RDMX TERMINATOR

Accessories

33400474 : CABLE 2X0,22 KR-SY LI2Y(ST)CH TP GREY

26000122 : SOCKET RDMX L:100cm 4 PIN MALE-FEMALE DOUBLE SIDED EXTENSION IP67 (YM)

26000150 : SOCKET RDMX L:200cm 4 PIN MALE-FEMALE DOUBLE SIDED EXTENSION IP67 (YM)

26000151 : SOCKET RDMX L:400cm 4 PIN MALE-FEMALE DOUBLE SIDED EXTENSION IP67 (YM)

26000152 : SOCKET RDMX L:600cm 4 PIN MALE-FEMALE DOUBLE SIDED EXTENSION IP67 (YM)

26000153 : SOCKET RDMX L:800cm 4 PIN MALE-FEMALE DOUBLE SIDED EXTENSION IP67 (YM)

26000154 : SOCKET RDMX L:1000cm 4 PIN MALE-FEMALE DOUBLE SIDED EXTENSION



RDMX

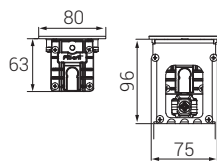
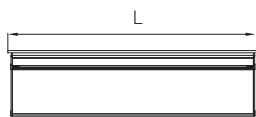

- Anodized aluminum extruded profile
- Polycarbonate luminaire glass
- PVC side covers with invisible gland outlet and UV protection
- Stainless steel fixture stand
- High efficiency group lens
- IP68 air vent
- RDMX configuration
- IP67 socket for DATA-SIGNALS

P W Product & Power Options

Product Name	Light Color	Input Voltage (V)	Power (W)	Length (L) (mm)	Weight (kg)
CFL109-RDMX	RGB	220-240V AC	12	380	2,5
CFL218-RDMX	RGB	220-240V AC	23	670	4,0
CFL327-RDMX	RGB	220-240V AC	34	960	5,1
CFL436 -RDMX	RGB	220-240V AC	45	1250	7,3
CFL112-RDMX	RGBW/A	220-240V AC	16	380	2,5
CFL224-RDMX	RGBW/A	220-240V AC	31	670	4,0
CFL336-RDMX	RGBW/A	220-240V AC	45	960	5,1
CFL448-RDMX	RGBW/A	220-240V AC	60	1250	2,9

O Lens Options



XN: Extra Narrow Angle
N: Narrow Angle
M: Medium Angle
W: Wide Angle
E: Elliptical Angle



NA: Asymmetrical Narrow Angle
MA: Asymmetrical Medium Angle

K Cable Direction Options

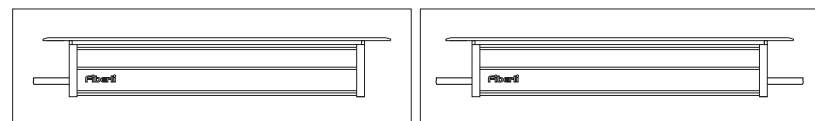

01: Single entry

03: Dual entry and exit

**Only for energy cable*

M Mounting Options

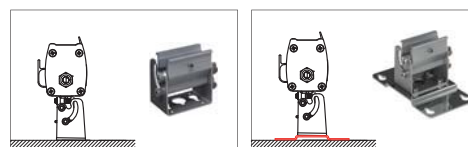

20: Standard Stand

21: Standard stand/
Mounting kit

Optional Accessories

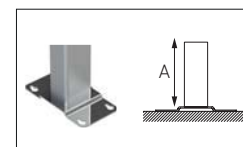

34: Extension piece A=5cm

35: Extension piece A=10cm

36: Extension piece A=20cm

Extension pieces at any desired length are optional



Order Code

P . W . O . K . M



Product Diagrams

Polar Diagram

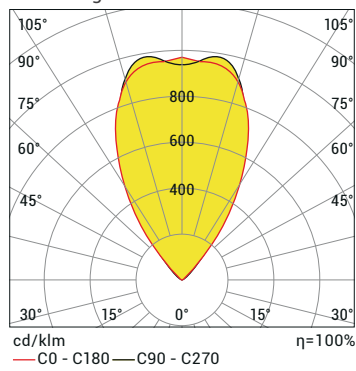

Standard Connection Scheme

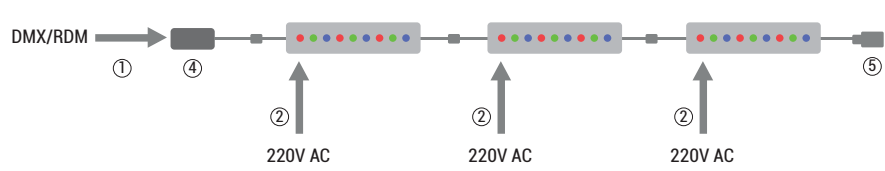

Connection Scheme with Extension Socket

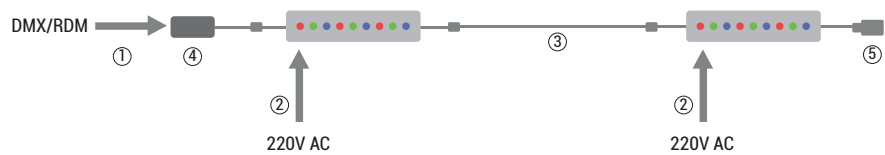

(1) DMX DATA CABLE, 33400474 : CABLE 2X0,22 KR-SY LI2Y(ST)CH TP GREY

(2) AC SUPPLY CABLE, 3x1mm TTR

(3) 26000xxx : SOCKET RDMX L:100/200/400/600/800/1000cm 4 PIN MALE-FEMALE DOUBLE SIDED EXTENSION IP67 (YM)



(4) 33600755: RDMX INPUT JOINT



(5) 33600696 : RDMX TERMINATOR

Accessories

33400474 : CABLE 2X0,22 KR-SY LI2Y(ST)CH TP GREY

26000122 : SOCKET RDMX L:100cm 4 PIN MALE-FEMALE DOUBLE SIDED EXTENSION IP67 (YM)

26000150 : SOCKET RDMX L:200cm 4 PIN MALE-FEMALE DOUBLE SIDED EXTENSION IP67 (YM)

26000151 : SOCKET RDMX L:400cm 4 PIN MALE-FEMALE DOUBLE SIDED EXTENSION IP67 (YM)

26000152 : SOCKET RDMX L:600cm 4 PIN MALE-FEMALE DOUBLE SIDED EXTENSION IP67 (YM)

26000153 : SOCKET RDMX L:800cm 4 PIN MALE-FEMALE DOUBLE SIDED EXTENSION IP67 (YM)

26000154 : SOCKET RDMX L:1000cm 4 PIN MALE-FEMALE DOUBLE SIDED EXTENSION



RDMX

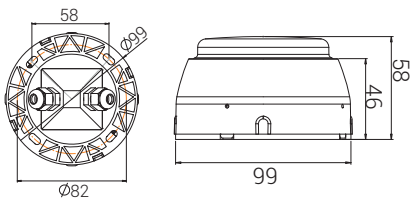

- Plastic injection body
- Polycarbonate luminaire glass
- RDM configuration
- IP67 socket for DATA-SIGNALS

P W Product & Power Options

Product Name	Light Color	Input Voltage (V)	Power (W)	Weight (kg)
DOT-RDMX-6	RGB	12-48V DC	2	0,2
DOT-RDMX-12	RGB	12-48V DC	3	0,2
DOT-RDMX-18	RGB	12-48V DC	5	0,2

G Housing Color Options

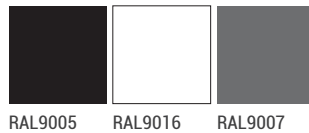

RAL9005 RAL9016 RAL9007

U Upper Piece Options



9: Difused

11: Transparent



Order Code

P . W . G . U



Standard Connection Scheme

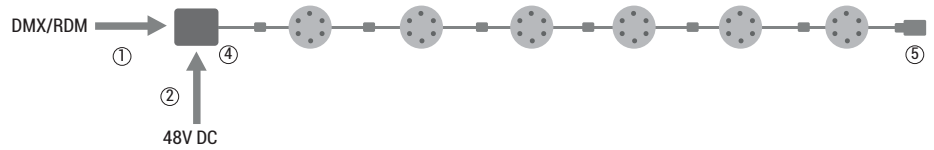

Connection Scheme with Extension Socket

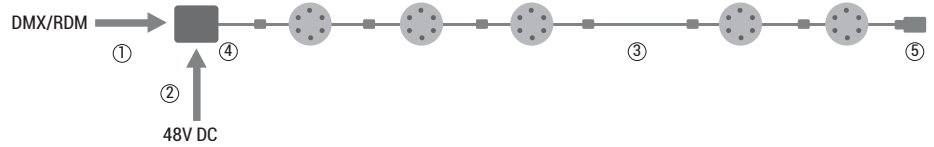

Combined Model Connection Scheme

DOT-RDMX-xx and LL-RDMX-xxx can be grouped together by DOT/LL combined chain model

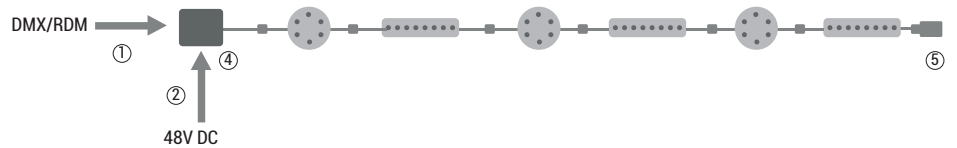

(1) DMX DATA CABLE, 33400474 : CABLE 2X0,22 KR-SY LI2Y(ST)CH TP GREY

(2) AC SUPPLY CABLE, 3x1mm TTR

(3) 26000xxx : SOCKET RDMX L:100/200/400/600/800/1000cm 4 PIN MALE-FEMALE DOUBLE SIDED EXTENSION IP67 (YM)



(4) 33600695 :RDMX INPUT JUNCTION BOX



(5) 33600696 : RDMX TERMINATOR

Accessories

33400474 : CABLE 2X0,22 KR-SY LI2Y(ST)CH TP GREY

26000122 : SOCKET RDMX L:100cm 4 PIN MALE-FEMALE DOUBLE SIDED EXTENSION IP67 (YM)

26000150 : SOCKET RDMX L:200cm 4 PIN MALE-FEMALE DOUBLE SIDED EXTENSION IP67 (YM)

26000151 : SOCKET RDMX L:400cm 4 PIN MALE-FEMALE DOUBLE SIDED EXTENSION IP67 (YM)

26000152 : SOCKET RDMX L:600cm 4 PIN MALE-FEMALE DOUBLE SIDED EXTENSION IP67 (YM)

26000153 : SOCKET RDMX L:800cm 4 PIN MALE-FEMALE DOUBLE SIDED EXTENSION IP67 (YM)

26000154 : SOCKET RDMX L:1000cm 4 PIN MALE-FEMALE DOUBLE SIDED EXTENSION